

ANNEX I
SUMMARY OF PRODUCT CHARACTERISTICS

▼ This medicinal product is subject to additional monitoring. This will allow quick identification of new safety information. Healthcare professionals are asked to report any suspected adverse reactions. See section 4.8 for how to report adverse reactions.

1. NAME OF THE MEDICINAL PRODUCT

Voxzogo 0.4 mg powder and solvent for solution for injection
Voxzogo 0.56 mg powder and solvent for solution for injection
Voxzogo 1.2 mg powder and solvent for solution for injection

2. QUALITATIVE AND QUANTITATIVE COMPOSITION

Voxzogo 0.4 mg powder and solvent for solution for injection

Each vial of powder contains 0.4 mg of vosoritide*.
After reconstitution, each vial contains 0.4 mg vosoritide in 0.5 mL of solution, corresponding to a concentration of 0.8 mg/mL.

Voxzogo 0.56 mg powder and solvent for solution for injection

Each vial of powder contains 0.56 mg of vosoritide*.
After reconstitution, each vial contains 0.56 mg vosoritide in 0.7 mL of solution, corresponding to a concentration of 0.8 mg/mL.

Voxzogo 1.2 mg powder and solvent for solution for injection

Each vial of powder contains 1.2 mg of vosoritide*.
After reconstitution, each vial contains 1.2 mg vosoritide in 0.6 mL of solution, corresponding to a concentration of 2 mg/mL.

*produced in *Escherichia coli* cells by recombinant DNA technology.

For the full list of excipients, see section 6.1.

3. PHARMACEUTICAL FORM

Powder and solvent for solution for injection.

The powder is white to yellow and the solvent is clear and colourless.

4. CLINICAL PARTICULARS

4.1 Therapeutic indications

Voxzogo is indicated for the treatment of achondroplasia in patients 4 months of age and older whose epiphyses are not closed. The diagnosis of achondroplasia should be confirmed by appropriate genetic testing.

4.2 Posology and method of administration

Treatment with vosoritide should be initiated and directed by a physician appropriately qualified in the management of growth disorders or skeletal dysplasias.

Posology

Voxzogo is given as a daily subcutaneous injection. The recommended dose is based on the patient's weight and is approximately between 15-30 µg/kg, where the higher dose is given to smallest children, see Table 1.

The dose can be administered using either mL graduated syringes or Unit (U) graduated syringes (see Table 1). The measurements for the Unit graduated syringes are equivalent to mL as follows: 0.1 mL = 10 Units. For practicality reasons and to account for weight-related PK changes (see section 5.2), the following dosing is recommended.

Table 1: Single dose volumes by body weight in mL and Units (U) volumes

| Body weight (kg) | Dose (mg) | Vosoritide 0.4 mg solvent (water for injections): 0.5 mL concentration: 0.8 mg/mL | | Vosoritide 0.56 mg solvent (water for injections): 0.7 mL concentration: 0.8 mg/mL | | Vosoritide 1.2 mg solvent (water for injections): 0.6 mL concentration: 2 mg/mL | |
|------------------|-----------|---|-------|--|-------|---|-------|
| | | mL | Units | mL | Units | mL | Units |
| | | Daily injection volume | | | | | |
| 4 | 0.12 mg | 0.15 mL | 15 U | | | | |
| 5 | 0.16 mg | 0.20 mL | 20 U | | | | |
| 6-7 | 0.20 mg | 0.25 mL | 25 U | | | | |
| 8-11 | 0.24 mg | 0.30 mL | 30 U | | | | |
| 12-16 | 0.28 mg | | | 0.35 mL | 35 U | | |
| 17-21 | 0.32 mg | | | 0.40 mL | 40 U | | |
| 22-32 | 0.40 mg | | | 0.50 mL | 50 U | | |
| 33-43 | 0.50 mg | | | | | 0.25 mL | 25 U |
| 44-59 | 0.60 mg | | | | | 0.30 mL | 30 U |
| 60-89 | 0.70 mg | | | | | 0.35 mL | 35 U |
| ≥ 90 | 0.80 mg | | | | | 0.40 mL | 40 U |

Duration of treatment

Treatment with this medicinal product should be stopped upon confirmation of no further growth potential, indicated by a growth velocity of < 1.5 cm/year and closure of epiphyses.

Missed dose

If a dose of vosoritide is missed, it can be administered within 12 hours. If more than 12 hours have passed since the original dosing schedule, the missed dose should NOT be administered.

Patients/caregivers should be advised to continue with the next scheduled dose the following day.

Growth monitoring

Patients should be monitored and assessed regularly every 3-6 months to check body weight, growth and physical development. Dose should be adjusted according to the patient's body weight (see Table 1).

Special populations

Patients with renal or hepatic impairment

The safety and efficacy of vosoritide in patients with renal or hepatic impairment has not been evaluated.

Paediatric population

The safety and efficacy of Voxzogo in children aged less than 4 months of age is limited. Currently available data are described in sections 4.8, 5.1 and 5.2, but no recommendation on a posology can be made.

Method of administration

Voxzogo is for subcutaneous single use only. This medicinal product must be administered within 3 hours of reconstitution.

Prior to injecting, a healthcare professional should:

- train caregivers on the preparation and subcutaneous injection of this medicinal product.
- train caregivers and patients to recognise signs and symptoms of decreased blood pressure.
- inform caregivers and patients what to do in the event of symptomatic decreases in blood pressure.

Patients and caregivers should be instructed to rotate sites for subcutaneous injections. Recommended injection sites on the body include the front middle of the thighs, the lower part of the abdomen except for 5 cm directly around the navel, top of the buttocks or the back of the upper arms. The same injection area should not be used on two consecutive days. Voxzogo should not be injected into sites that are red, swollen, or tender.

Patients should be well hydrated at the time of injection. It is recommended patients eat a light snack and drink an adequate amount of fluid (e.g., water, milk, juice, etc.) about 30 minutes before injecting. This is to reduce the signs and symptoms of potential decreases in blood pressure (dizziness, fatigue and/or nausea) (see section 4.4, Blood pressure effects).

If possible, this medicinal product should be injected at approximately the same time each day.

For instructions on reconstitution of the medicinal product before administration, see section 6.6.

4.3 Contraindications

Hypersensitivity to the active substance(s) or to any of the excipients listed in section 6.1.

4.4 Special warnings and precautions for use

Traceability

In order to improve the traceability of biological medicinal products, the name and the batch number of the administered medicinal product should be clearly recorded.

Blood pressure effects

Patients with significant cardiac or vascular disease and patients on anti-hypertensive medicinal products were excluded from participation in premarketing clinical trials.

To reduce the risk of a potential decrease in blood pressure and associated symptoms (dizziness, fatigue and/or nausea), patients should be well hydrated at the time of injection (see sections 4.2 and 4.8).

Sodium

This medicinal product contains less than 1 mmol sodium (23 mg) per unit volume, that is to say essentially 'sodium-free'.

4.5 Interaction with other medicinal products and other forms of interaction

In vitro cytochrome P450 (CYP) inhibition and induction studies and *in vitro* transporter inhibition studies have been performed. Results suggested that vosoritide is unlikely to cause CYP- or transporter-mediated drug-drug interactions in humans when the medicinal product is administered concomitantly with other medicinal products.

No other interaction studies have been performed. Because it is a recombinant human protein, vosoritide is an unlikely candidate for drug-drug interactions.

4.6 Fertility, pregnancy and lactation

Pregnancy

There are no or limited amount of data from the use of vosoritide in pregnant women. Animal studies do not indicate direct or indirect harmful effects with respect to reproductive toxicity (see section 5.3). As a precautionary measure, it is preferable to avoid the use of vosoritide during pregnancy.

Breast-feeding

Available pharmacodynamic/toxicological data in animals have shown excretion of vosoritide in milk (see section 5.3). A risk to newborns/infants cannot be excluded. Vosoritide should not be used during breast-feeding.

Fertility

No impairment of male or female fertility has been observed in nonclinical studies (see section 5.3).

4.7 Effects on ability to drive and use machines

Voxzogo has moderate influence on the ability to drive, cycle and use machines. Vosoritide may cause transient decreases in blood pressure that are usually mild but syncope, pre-syncope, and dizziness, as well as other signs and symptoms of decreased blood pressure have been reported as adverse reactions with Voxzogo. The patient's response to treatment should be considered and if appropriate, advised not to drive, cycle or use machines for at least 60 minutes after injection.

4.8 Undesirable effects

Summary of the safety profile

The most common adverse reactions to vosoritide were injection site reactions (85%), vomiting (27%), and decreased blood pressure (13%).

Tabulated list of adverse reactions

Adverse reactions in patients treated with vosoritide are tabulated below.

Adverse reactions are listed below by MedDRA system organ class and by frequency. Frequencies are defined as very common ($\geq 1/10$); common ($\geq 1/100$ to $< 1/10$); uncommon ($\geq 1/1\ 000$ to $< 1/100$); rare ($\geq 1/10\ 000$ to $< 1/1\ 000$); very rare ($< 1/10\ 000$); not known (cannot be estimated from available data). Within each frequency grouping, adverse reactions are presented in order of decreasing seriousness.

Table 2: Adverse reactions in patients treated with Voxzogo

| System organ class | Very common | Common | Uncommon |
|--|--------------------------------------|-------------|----------------|
| Nervous system disorders | | Syncope | |
| | | Pre-syncope | |
| | | Dizziness | |
| Vascular disorders | Hypotension ^a | | |
| Gastrointestinal disorders | Vomiting | Nausea | |
| Skin and subcutaneous tissue disorders | | | Hypertrichosis |
| General disorders and administration site conditions | Injection site reaction ^b | Fatigue | |
| Investigations | Increased alkaline phosphatase | | |

^a. Hypotension includes both asymptomatic and symptomatic adverse reactions.

^b. Injection site reactions include the preferred terms; injection site erythema, injection site reaction, injection site swelling, injection site urticaria, injection site pain, injection site bruising, injection site pruritus, injection site haemorrhage, injection site discolouration, and injection site induration.

Description of selected adverse reactions

Hypotension

In ACH study 111-301, patients aged ≥ 5 years, 13% of patients treated with vosoritide compared to 5% of patients treated with placebo, experienced events of decreases in blood pressure which were transient and resolved without intervention. The median time to onset from injection was 31 (18 to 120) minutes with resolution within 31 (5 to 90) minutes. The reported events were identified predominantly during periods of frequent vital signs monitoring at clinical visits after dosing over a 52-week treatment period. 2% of patients had a symptomatic episode with dizziness and vomiting.

In study 111-206, events of decrease in blood pressure occurred in 2 patients (5%) aged < 5 years treated with vosoritide compared to 2 patients (6%) on placebo. In patients > 2 years to < 5 years of age, events of decrease in blood pressure were reported in 1 patient (5%) treated with vosoritide compared to 1 patient (6%) on placebo. In patients 6 months to < 2 years of age, events of decrease in blood pressure were reported in 0 patients treated with vosoritide compared to 1 patient (13%) on placebo. In patients < 6 months of age, events of decrease in blood pressure were reported in 1 patient (8%) treated with vosoritide compared to 0 patients on placebo. All events were transient, resolved without intervention and were not treatment limiting.

Injection site reactions

In ACH study 111-301, in patients aged ≥ 5 years, injection site reactions were reported in 85% patients treated with vosoritide compared to 82% patients on placebo. Patients receiving this medicinal product who experienced injection site reactions reported a median of 76 events, compared to patients receiving placebo who reported a median of 7.5 events over a 52-week period. The most common injection site reactions (occurring in at least 10% of patients treated with vosoritide) were injection site reaction (73%), injection site erythema (68%), injection site swelling (38%), and injection site urticaria (13%). All injection site reactions were Grade 1 (mild) in severity, with the exception of 5 events in two patients that were Grade 2 (moderate). Reported Grade 2 events included; two patients who reported two events of injection site urticaria, and one event of injection site vesicles.

In study 111-206, patients aged < 5 years, injections site reactions were reported in 86% of patients treated with vosoritide compared to 53% patients on placebo. Patients receiving vosoritide who experienced injection site reactions reported a median of 224 events, compared to patients receiving placebo who reported a median of 114 events over a 52-week period, all of which were Grade 1 (mild) in severity. In patients > 2 years to < 5 years of age, injection site reactions were reported in 84% patients treated with vosoritide compared to 44% patients on placebo. In patients 6 months to < 2 years of age, events of injection site reactions were reported in 83% patients treated with vosoritide

compared to 50% patients on placebo. In patients < 6 months of age, injection site reactions were reported in 92% patients treated with vosoritide compared to 75% patients on placebo.

Across all age groups, injection site reactions were transient, and not treatment limiting.

Immunogenicity

Of 131 patients aged 5 years of age and older with achondroplasia who were treated with vosoritide 15 µg/kg/day and evaluable for the presence of anti-drug antibodies (ADA) for up to 240 weeks, ADA were detected in 35% of patients. The earliest time to ADA development was day 85. All ADA-positive patients tested negative for anti-vosoritide neutralising antibodies. There was no correlation between the number, duration, or severity of hypersensitivity adverse reactions or injection site reactions and ADA positivity or mean ADA titre. There was no association between ADA positivity or mean ADA titre and change from baseline in annual growth velocity (AGV) or height Z-score at Month 12. There was no impact of serum ADA detected on the plasma PK measurements of vosoritide.

In patients under 5 years of age, 19% (8/43) of vosoritide-treated patients tested positive for ADA and all placebo-treated patients tested negative for ADA. The earliest time to ADA development was week 26. All of the ADA-positive patients tested negative for neutralising anti-drug antibodies (NAb) at all time points. There was no impact of ADA development on safety, efficacy or PK of vosoritide.

Reporting of suspected adverse reactions

Reporting suspected adverse reactions after authorisation of the medicinal product is important. It allows continued monitoring of the benefit/risk balance of the medicinal product. Healthcare professionals are asked to report any suspected adverse reactions via the national reporting system listed in [Appendix V](#).

4.9 Overdose

In clinical trials, doses of vosoritide were explored up to 30 µg/kg/day. Two patients received up to 3 times the recommended daily dose of 15 µg/kg/day for up to 5-weeks. No signs, symptoms or adverse reactions associated with the higher than intended dose were observed.

In the event a patient takes more than they should, the patient should contact their healthcare professional.

5. PHARMACOLOGICAL PROPERTIES

5.1 Pharmacodynamic properties

Pharmacotherapeutic group: Drugs for treatment of bone diseases, other drugs affecting bone structure and mineralisation, ATC code: M05BX07

Mechanism of action

Vosoritide is a modified type C natriuretic peptide (CNP). In patients with achondroplasia, endochondral bone growth is negatively regulated due to a gain of function mutation in fibroblast growth factor receptor 3 (*FGFR3*). Binding of vosoritide to natriuretic peptide receptor-B (NPR-B) antagonises *FGFR3* downstream signalling by inhibiting the extracellular signal-regulated kinases 1 and 2 (ERK1/2) in the mitogen-activated protein kinase (MAPK) pathway at the level of rapidly accelerating fibrosarcoma serine/threonine protein kinase (RAF-1). As a result, vosoritide, like CNP, acts as a positive regulator of endochondral bone growth as it promotes chondrocyte proliferation and differentiation.

Pharmacodynamic effects

Exposure-dependent (AUC and C_{max}) increases from baseline in urinary cyclic guanosine monophosphate (cGMP, a biomarker for NPR-B activity) concentrations and serum collagen type X marker (CXM, a biomarker for endochondral ossification) were observed on treatment with vosoritide. Increase in the urinary cGMP concentrations from pre-dose baseline took place within the first four hours post-dose. Median serum CXM concentration increased over baseline by day 29 of daily administration of this medicinal product. This effect was maintained beyond 24 months of treatment. Vosoritide activity as measured by urine cGMP was near saturation while maximal increase in growth plate activity indicated by CXM was achieved at the dose of 15 µg/kg administered subcutaneously once daily.

Clinical efficacy and safety

The efficacy and safety of vosoritide in patients with achondroplasia with confirmed FGFR3 mutation were assessed in a randomised, double-blind, placebo-controlled 52-week study (ACH study 111-301). In ACH study 111-301, patients were randomised to either vosoritide (n=60) or placebo (n=61) and the dose of vosoritide was 15 µg/kg administered subcutaneously once daily. Prior to randomisation, all patients enrolled in an observational study (ACH study 111-901) for paediatric patients with achondroplasia for at least a 6-month period during which baseline standing height and other pre-treatment growth assessments were collected. Patients with limb-lengthening surgery in the prior 18 months or who planned to have limb-lengthening surgery during the study period were excluded. The study comprised a 52-week placebo-controlled treatment phase followed by an open-label treatment extension study in which all patients received vosoritide. The primary efficacy endpoint was the change from baseline in AGV at Week 52 compared with placebo.

Patients with achondroplasia were also treated with vosoritide 15 µg/kg/day in an open label, dose-escalation study and in its long-term extension study (ACH study 111-205). Data was collected from observational studies in patients to characterise the natural history of achondroplasia. Height data from untreated patients with achondroplasia in the same age range as the clinical studies was used as an historical control to assess the effect on height after up to 5 years of vosoritide treatment.

Patient demographics and baseline characteristics are shown in Table 3.

Table 3: Patient demographics and characteristics in ACH study 111-301 and ACH study 111-205

| Parameter | ACH study 111-301 | | ACH study 111-205 ^b |
|------------------------------------|-------------------|-----------------------------------|-----------------------------------|
| | Placebo (N=61) | 15 µg/kg/day Voxzogo (N=60) | 15 µg/kg/day Voxzogo (N=10) |
| Age at day 1 (years) | | | |
| Mean (SD) | 9.06 (2.47) | 8.35 (2.43) | 8.54 (1.54) |
| Min, max | 5.1, 14.9 | 5.1, 13.1 | 6.3, 11.1 |
| Age at day 1, n (%) ^a | | | |
| ≥ 5 to < 8 years | 24 (39.3) | 31 (51.7) | 4 (40.0) |
| ≥ 8 to < 11 years | 24 (39.3) | 17 (28.3) | 5 (50.0) |
| ≥ 11 to < 15 years | 13 (21.3) | 12 (20.0) | 1 (10.0) |
| Tanner stage b, n (%) ^a | | | |
| I | 48 (78.7) | 48 (80.0) | 10 (100.0) |
| > I | 13 (21.3) | 12 (20.0) | |
| Sex, n (%) ^a | | | |
| Male | 33 (54.1) | 31 (51.7) | 4 (40.0) |
| Female | 28 (45.9) | 29 (48.3) | 6 (60.0) |
| Weight (kg) | | | |
| Mean (SD) | 24.62 (9.07) | 22.88 (7.96) | 25.13 (5.74) |
| Min, max | 11.6, 68.9 | 13.6, 53.0 | 18.2, 36.4 |

max, maximum; min, minimum; SD, standard deviation.

^a Percentages were calculated using the total number of patients in the full analysis set (N for each treatment group) as the denominator

^b Analysis from 10 out of 35 patients who only received 15 µg/kg/day in an open label, dose-escalation study and continued into the long-term extension ACH study 111-205

In ACH study 111-301, improvements in AGV and height Z-score from baseline were observed in patients treated with Voxzogo 15 µg/kg/day compared with placebo. Efficacy results are shown in Table 4.

Table 4: Results from placebo-controlled clinical trial

| | Placebo (N=61) | | | Voxzogo 15 µg/kg daily (N=60 ^c) | | | Voxzogo vs. placebo |
|---|-------------------|-----------------|-----------------|--|-----------------|----------------|--|
| | Baseline | Week 52 | Change | Baseline | Week 52 | Change | LS Mean difference in changes (95% CI) |
| Annualised growth velocity (cm/year) | | | | | | | |
| Mean ± SD | 4.06 ± 1.20 | 3.94 ± 1.07 | -0.12 ± 1.74 | 4.26 ± 1.53 | 5.61 ± 1.05 | 1.35 ± 1.71 | 1.57^a (1.22, 1.93) (p = < 0.0001)^b |
| Height Z-score | | | | | | | |
| Mean ± SD | -5.14 ± 1.07 | -5.14 ± 1.09 | 0.00 ± 0.28 | -5.13 ± 1.11 | -4.89 ± 1.09 | 0.24 ± 0.32 | 0.28^a (0.17, 0.39) (p = < 0.0001)^b |

AGV, annualised growth velocity; 95% CI, 95% confidence interval; LS, least-square; SD, standard deviation.

^a Difference is 15 µg/kg Voxzogo minus placebo.

^b Two-sided p-value.

^c Two patients in the Voxzogo group discontinued from the study before Week 52. The values for these 2 patients were imputed for this analysis.

LS mean estimated from the ANCOVA (analysis of covariance) model adjusted for baseline differences between the two arms, analysis of covariance.

The benefit of improvement in AGV in favour of Voxzogo was consistent across all predefined subgroups analysed including sex, age group, Tanner stage, baseline height Z-score, and baseline AGV. In the subgroup of males Tanner stage > I, the point estimate of treatment effect was in favour of vosoritide however there were only 8 subjects in this subgroup (3 and 5 subjects in vosoritide and placebo arms, respectively).

The observed increase in growth occurred proportionally in both the spine and the lower limbs. There was no difference in bone mineral density after treatment with Voxzogo compared to placebo. During treatment with this medicinal product, the mean increase in bone age was comparable to the mean increase in chronological age, indicating no acceleration of bone maturation.

Figure 1 shows the effect of Voxzogo over the two-year period in the Voxzogo treatment group, as well as the effect in the placebo control group after receiving daily subcutaneous injections of Voxzogo for 52 weeks in the open label extension study. Improvements in AGV were maintained during continued Voxzogo therapy, with no evidence of tachyphylaxis.

Figure 1: Mean (\pm SD) 12-Month Interval AGV Over Time

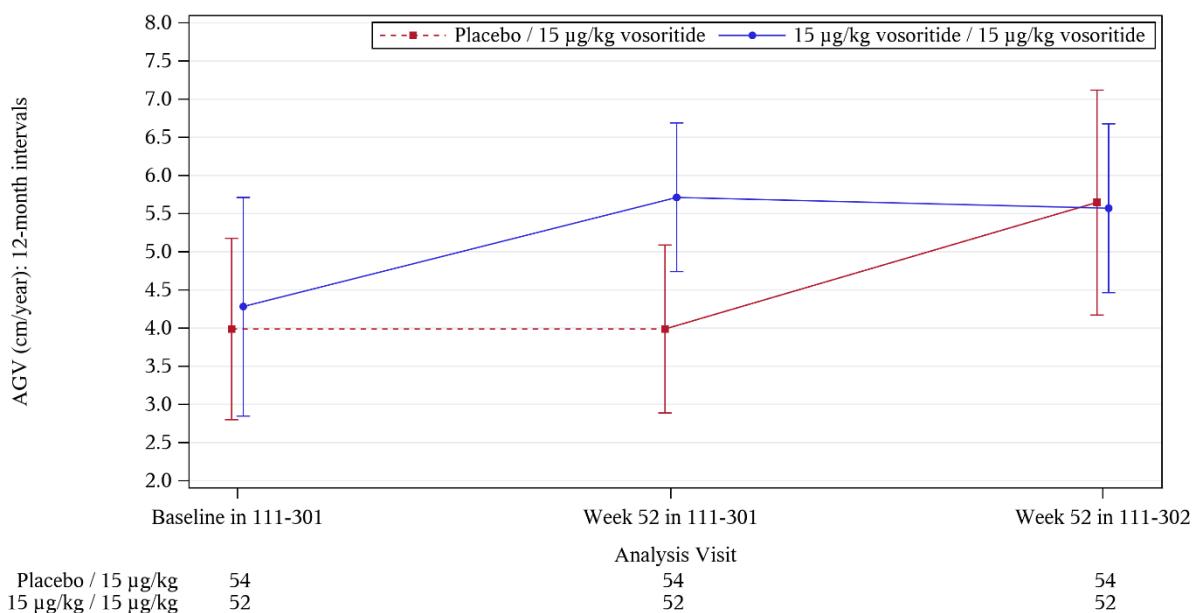

The figure includes all subjects enrolled in the pivotal trial who had a height assessment at week 52 in the extension study. Solid lines represent treatment with vosoritide 15 µg/kg; dashed lines represent placebo. Baseline is defined as the last assessment before the first dose of active study drug (i.e. vosoritide) or Placebo in 111-301.

12-Month AGV at post-baseline visits is derived over the previous 12 months. For example, 12-Month Interval AGV at Week 52 111-302 = [(Height at Week 52 111-302 Visit - Height at Week 52 111-301 Visit)/(Date of Week 52 111-302 Visit - Date of Week 52 111-301 Visit)] x 365.25.

Open-label extension study

In the long-term extension study (ACH study 111-205), 10 patients were treated with Voxzogo 15 µg/kg/day dose continuously for up to 5 years. The mean (SD) improvement in AGV compared to baseline at 60 months was 1.34 (1.31) cm/year.

The gain in height after 5 years of treatment with 15 µg/kg/day of Voxzogo was compared with an age and sex matched historical control. The 5-year cross-sectional comparative analysis adjusted for baseline height differences, demonstrated, there was a statistically significant mean (95% CI) difference in height in favour of Voxzogo (9.08 [5.77, 12.38] cm; p=0.0002) compared with untreated patients with achondroplasia.

Paediatric population <5 years

A total of 75 patients aged 4.4 months to 59.8 months at day 1 of dosing were enrolled in a randomized, double-blind, placebo-controlled 52-week study. At least 6 months of baseline growth data were collected in the observational study for patients who were aged 6 months and over at randomization, and at least 3-months baseline data for those subjects aged under 6 months at randomization. A total of 64 patients were randomised to receive vosoritide treatment or placebo and 11 patients received open-label treatment. At 52 weeks, patients treated with vosoritide had an improvement in Height Z-score +0.30 SDS (95% CI 0.07, 0.54) compared to placebo.

Nine children aged >24 to <60 months were treated with vosoritide for 3 years and showed an improvement in Height Z-score of + 1.22 SDS (95% CI 0.78, 1.66) and a LS mean difference in height of 5.73 cm (95%CI 3.54, 7.93) compared with an age and sex matched historical control of untreated patients with achondroplasia.

Eleven children aged >6 to <24 months were treated with vosoritide for 2 years and showed an improvement in Height Z-score of + 0.79 SDS (95% CI 0.29, 1.28) and a LS mean difference in height of 2.69 cm (95%CI 1.00, 4.38) compared with an age and sex matched historical control of untreated patients with achondroplasia.

5.2 Pharmacokinetic properties

Vosoritide is a modified recombinant human CNP. The 39 amino acid peptide analogue includes the 37 C terminal amino acids of the human CNP53 sequence plus the addition of 2 amino acids (Pro Gly) to convey resistant to neutral endopeptidase (NEP) degradation, resulting in prolonged half-life in comparison to endogenous CNP.

The pharmacokinetics of vosoritide were evaluated in a total of 58 patients aged 5 to 18 years with achondroplasia who received subcutaneous injections of vosoritide 15 µg/kg once daily for 52 weeks. The pharmacokinetic exposure of vosoritide in 15 patients aged 2 to < 5 years old were comparable with older children.

In 8 patients aged 6 months to < 2 years old, receiving 30 µg/kg once daily the pharmacokinetic exposure of vosoritide was 65% to 70% higher than the older children (> 2 years old) receiving 15 µg/kg once daily. In 9 patients < 6 months of age receiving 30 µg/kg once daily, the pharmacokinetic exposure of vosoritide was 57% to 105% higher than the older children (> 2 years old) receiving 15 µg/kg once daily.

Absorption

Vosoritide was absorbed with a median T_{max} of 15 minutes. The mean (\pm SD) peak concentration (C_{max}) and area under the concentration-time curve from time zero to the last measurable concentration (AUC_{0-t}) observed after 52 weeks of treatment was 5 800 (\pm 3 680), and 290 000 (\pm 235 000) pg-min/mL respectively. The bioavailability of vosoritide was not assessed in clinical studies.

Distribution

The mean (\pm SD) apparent volume of distribution after 52 weeks of treatment was 2 910 (\pm 1 660) mL/kg.

Biotransformation

The metabolism of vosoritide is expected to occur via catabolic pathways and be degraded into small peptide fragments and amino acids.

Elimination

The mean (\pm SD) apparent clearance after 52 weeks of treatment was 79.4 (53.0) mL/min/kg. The mean (\pm SD) half-life was 27.9 (9.9) minutes.

The inter-subject variability (coefficient of variation) in apparent clearance was 33.6 %.

Linearity/non-linearity

The increase in plasma exposure (AUC and C_{max}) with dose was greater than dose proportional across the dose range of 2.5 (0.17 times the recommended dose) to 30.0 µg/kg/day (twice the approved dose).

Special populations

No clinically significant differences in the vosoritide pharmacokinetics was observed based on age (0.9 to 16 years), sex, race or ethnicity.

Body weight

Body weight is the only significant covariate for vosoritide clearance or volume of distribution. The apparent clearance and volume of distribution of vosoritide increased with increasing body weight in patients with achondroplasia (9 to 74.5 kg). The proposed posology (see section 4.2) takes account of this deviation and recommends the use of doses above (in patients between 10 and 16 kg body weight), or below (in those above a body weight of 44 kg) the 15 µg/kg “standard dose” in order to enable a similar level of exposure across all weight-ranges.

Patients with renal and hepatic impairment

The safety and efficacy of vosoritide in patients with renal or hepatic impairment has not been evaluated. Based on the elimination mechanism, renal or hepatic impairment is not expected to alter the pharmacokinetics of vosoritide.

Drug interaction studies

In vitro cytochrome P450 (CYP) inhibition and induction studies indicated that vosoritide did not inhibit CYP 1A2, 2B6, 2C8, 2C9, 2C19, 2D6, or 3A4/5, nor induce CYP 1A2, 2B6, or 3A4/5 at clinically relevant concentrations. *In vitro* interaction studies also indicated that the potential for interaction with the drug-transporters OAT1, OAT3, OCT 1, OCT 2, OATP1B1, OATP1B3, MATE 1, KATE2-K, BCRP, P-gp, and BSEP is low at clinically relevant concentrations.

5.3 Preclinical safety data

Adverse reactions not observed in clinical studies but seen in animals at exposure levels similar to clinical exposure levels, and with possible relevance to clinical use.

Transient decreases in blood pressure and increases in heart rate were observed in healthy monkeys across multiple studies in doses of 28 to 300 µg/kg in a dose-related manner. Peak effects were typically observed within the first hour post dose and were generally asymptomatic. In some monkeys receiving higher doses of vosoritide, brief bouts of sternal/lateral recumbency or hypoactivity, were observed. These effects could be related to decreased blood pressure.

Adverse effects on body posture, bone shape, mobility, and bone strength were observed in normal animals in repeat-dose toxicity studies in rats and monkeys. In monkeys, the NOAEL for vosoritide is 25 µg/kg (mean C_{max} value of 1 170 pg/mL; approximately equivalent to the recommended human dose in a 20 kg human) when administered daily via subcutaneous injection for 44 weeks.

Carcinogenicity / mutagenicity

Carcinogenicity and genotoxicity studies have not been performed with vosoritide. Based on the mechanism of action, vosoritide is not expected to be tumorigenic.

Impairment of fertility

In a fertility and reproductive study in male and female rats at dose levels up to 540 µg/kg/day, vosoritide had no effect on mating performance, fertility, or litter characteristics.

Reproductive and developmental toxicity

Vosoritide was not associated with effects on reproductive performance, in utero or developmental parameters measured in rats and rabbits to investigate fertility, or embryo-foetal development in pre- and post-natal development studies.

Vosoritide was detected in the breast milk in rats.

6. PHARMACEUTICAL PARTICULARS

6.1 List of excipients

Powder

Citric acid (E 330)
Sodium citrate (E 331)
Trehalose dihydrate
Mannitol (E 421)
Methionine
Polysorbate 80 (E 433)

Solvent

Water for injections

6.2 Incompatibilities

This medicinal product must not be mixed with other medicinal products except those mentioned in section 6.6.

6.3 Shelf life

Unopened vials

3 years

Reconstituted solution

Chemical and physical stability has been demonstrated for 3 hours at 25°C.

From a microbiological point of view, unless the method of reconstitution precludes the risk of microbial contamination, the solution should be used immediately.

If not used immediately, Voxzogo must be administered within 3 hours of reconstitution (see section 4.2).

6.4 Special precautions for storage

Store in a refrigerator (2 °C – 8 °C). Do not freeze.

Store in the original package in order to protect from light.

Voxzogo may be stored at room temperature below 30 °C for a single period up to 90 days, but not beyond the expiry date. Do not return Voxzogo to refrigerator after storage at room temperature.

For storage conditions after reconstitution of the medicinal product, see section 6.3.

6.5 Nature and contents of container

Vosoritide 0.4 mg powder and solvent for solution for injection

Powder

2 mL vial (glass) with rubber stopper (bromobutyl) and white flip cap.

Solvent

Pre-filled syringe (glass) with plunger (bromobutyl) and tip cap with a luer lock and tamper evident seal containing 0.5 mL of water for injections.

Vosoritide 0.56 mg powder and solvent for solution for injection

Powder

2 mL vial (glass) with rubber stopper (bromobutyl) and magenta flip cap.

Solvent

Pre-filled syringe (glass) with plungers (bromobutyl) and tip cap with a luer lock and tamper evident seal containing 0.7 mL of water for injections.

Vosoritide 1.2 mg powder and solvent for solution for injection

Powder

2 mL vial (glass) with rubber stopper (bromobutyl) and grey flip cap.

Solvent

Pre-filled syringe (glass) with plungers (bromobutyl) and tip cap with a luer lock and tamper evident seal containing 0.6 mL of water for injections

Each carton contains:

- 10 vials of Voxzogo
- 10 pre-filled syringes of water for injections
- 10 individual single use needles (23 gauge, for reconstitution)
- 10 individual single use syringes (30 gauge, for administration)

6.6 Special precautions for disposal and other handling

Preparation of Voxzogo for subcutaneous injection

- The correct Voxzogo strength and correct pre-filled syringe of solvent (reconstitution volume) should be confirmed based on the patient's body weight (see Table 1).
- All necessary ancillary supplies must be in place before starting.
 - Alcohol pads
 - Gauze or bandages
 - Sharps container
- The Voxzogo vial and solvent in a pre-filled syringe (water for injections) should be removed from the refrigerator and allowed to reach room temperature before reconstituting Voxzogo.
- The solvent needle must be attached to the solvent in the pre-filled syringe (water for injections).
- The entire solvent volume must be injected into the vial.
- The solvent in the vial should be gently swirled until the white powder is completely dissolved. The vial should not be shaken.
- The dosing volume of the reconstituted solution should be slowly withdrawn from the single use vial into a syringe.
- Once reconstituted this medicinal product is a clear, colourless to yellow liquid. The solution should not be used if discoloured or cloudy, or if particles are present.
- After reconstitution, Voxzogo can be held in the vial at a room temperature up to 25 °C for a maximum of 3 hours. The medicinal product contains no preservative.
- For administration, the required dose volume must be extracted from the vial using the supplied administration syringe (see Table 1).
- Each vial and pre-filled syringe are for single use only.
- Only the administration syringe provided should be used.

Disposal

Any unused medicinal product or waste material should be disposed of in accordance with local requirements.

All needles and syringes should be disposed of in a sharps disposal container.

7. MARKETING AUTHORISATION HOLDER

BioMarin International Limited
Shanbally, Ringaskiddy
County Cork, P43 R298
Ireland

8. MARKETING AUTHORISATION NUMBER(S)

EU/1/21/1577/001 10 x 0.4 mg Powder and solvent for solution for injection
EU/1/21/1577/002 10 x 0.56 mg Powder and solvent for solution for injection
EU/1/21/1577/003 10 x 1.2 mg Powder and solvent for solution for injection

9. DATE OF FIRST AUTHORISATION/RENEWAL OF THE AUTHORISATION

Date of first authorisation: 26 August 2021

10. DATE OF REVISION OF THE TEXT

Detailed information on this medicinal product is available on the website of the European Medicines Agency <https://www.ema.europa.eu>.

ANNEX II

- A. MANUFACTURER(S) OF THE BIOLOGICAL ACTIVE SUBSTANCE(S)
AND MANUFACTURER(S) RESPONSIBLE FOR BATCH RELEASE**
- B. CONDITIONS OR RESTRICTIONS REGARDING SUPPLY AND USE**
- C. OTHER CONDITIONS AND REQUIREMENTS OF THE MARKETING
AUTHORISATION**
- D. CONDITIONS OR RESTRICTIONS WITH REGARD TO THE SAFE AND
EFFECTIVE USE OF THE MEDICINAL PRODUCT**

A. MANUFACTURER(S) OF THE BIOLOGICAL ACTIVE SUBSTANCE(S) AND MANUFACTURER(S) RESPONSIBLE FOR BATCH RELEASE

Name and address of the manufacturer(s) of the biological active substance(s)

BioMarin Pharmaceutical Inc.
Novato Campus
46 Galli Drive
Novato, CA 94949
USA

Name and address of the manufacturer(s) responsible for batch release

BioMarin International Limited
Shanbally, Ringaskiddy
County Cork
P43 R298
Ireland

B. CONDITIONS OR RESTRICTIONS REGARDING SUPPLY AND USE

Medicinal product subject to restricted medical prescription (see Annex I: Summary of Product Characteristics, section 4.2).

C. OTHER CONDITIONS AND REQUIREMENTS OF THE MARKETING AUTHORISATION

• **Periodic safety update reports (PSURs)**

The requirements for submission of PSURs for this medicinal product are set out in the list of Union reference dates (EURD list) provided for under Article 107c(7) of Directive 2001/83/EC and any subsequent updates published on the European medicines web-portal.

D. CONDITIONS OR RESTRICTIONS WITH REGARD TO THE SAFE AND EFFECTIVE USE OF THE MEDICINAL PRODUCT

• **Risk management plan (RMP)**

The marketing authorisation holder (MAH) shall perform the required pharmacovigilance activities and interventions detailed in the agreed RMP presented in Module 1.8.2 of the marketing authorisation and any agreed subsequent updates of the RMP.

An updated RMP should be submitted:

- At the request of the European Medicines Agency;
- Whenever the risk management system is modified, especially as the result of new information being received that may lead to a significant change to the benefit/risk profile or as the result of an important (pharmacovigilance or risk minimisation) milestone being reached.

ANNEX III
LABELLING AND PACKAGE LEAFLET

A. LABELLING

PARTICULARS TO APPEAR ON THE OUTER PACKAGING

0.4 MG CARTON

1. NAME OF THE MEDICINAL PRODUCT

Voxzogo 0.4 mg powder and solvent for solution for injection
vosoritide

2. STATEMENT OF ACTIVE SUBSTANCE(S)

Each vial of powder contains 0.4 mg of vosoritide. After reconstitution, each vial contains 0.4 mg vosoritide in 0.5 mL of solution, corresponding to a concentration of 0.8 mg/mL.

3. LIST OF EXCIPIENTS

Powder: citric acid (E 330), sodium citrate (E 331), trehalose dihydrate, mannitol (E 421), methionine, polysorbate 80 (E 433)
Solvent: water for injections.

4. PHARMACEUTICAL FORM AND CONTENTS

Powder and solvent for solution for injection.

This carton contains:
10 powder vials (0.4 mg)
10 syringes with solvent (0.5 mL)
10 single use needles
10 single use syringes

5. METHOD AND ROUTE(S) OF ADMINISTRATION

For single use only.
Read the package leaflet before use.
Subcutaneous use.

6. SPECIAL WARNING THAT THE MEDICINAL PRODUCT MUST BE STORED OUT OF THE SIGHT AND REACH OF CHILDREN

Keep out of the sight and reach of children.

7. OTHER SPECIAL WARNING(S), IF NECESSARY

8. EXPIRY DATE

EXP

9. SPECIAL STORAGE CONDITIONS

Store in a refrigerator. Do not freeze.

Can be stored at room temperature below 30 °C for a single period up to 90 days.

Store in the original package in order to protect from light.

Date removed from refrigeration: ____/____/____

If not used immediately, vosoritide must be administered within 3 hours of reconstitution.

10. SPECIAL PRECAUTIONS FOR DISPOSAL OF UNUSED MEDICINAL PRODUCTS OR WASTE MATERIALS DERIVED FROM SUCH MEDICINAL PRODUCTS, IF APPROPRIATE**11. NAME AND ADDRESS OF THE MARKETING AUTHORISATION HOLDER**

BioMarin International Limited
Shanbally, Ringaskiddy
County Cork
Ireland
P43 R298

12. MARKETING AUTHORISATION NUMBER(S)

EU/1/21/1577/001

13. BATCH NUMBER

Lot

14. GENERAL CLASSIFICATION FOR SUPPLY**15. INSTRUCTIONS ON USE****16. INFORMATION IN BRAILLE**

Voxzogo 0.4 mg

17. UNIQUE IDENTIFIER – 2D BARCODE

2D barcode carrying the unique identifier included.

18. UNIQUE IDENTIFIER - HUMAN READABLE DATA

PC
SN
NN

MINIMUM PARTICULARS TO APPEAR ON SMALL IMMEDIATE PACKAGING UNITS

0.4 MG VIAL LABEL

1. NAME OF THE MEDICINAL PRODUCT AND ROUTE(S) OF ADMINISTRATION

Voxzogo 0.4 mg powder for injection
vosoritide
SC use

2. METHOD OF ADMINISTRATION

3. EXPIRY DATE

EXP

4. BATCH NUMBER

Lot

5. CONTENTS BY WEIGHT, BY VOLUME OR BY UNIT

0.4 mg

6. OTHER

MINIMUM PARTICULARS TO APPEAR ON SMALL IMMEDIATE PACKAGING UNITS

0.5 ML SOLVENT PRE-FILLED SYRINGE LABEL

1. NAME OF THE MEDICINAL PRODUCT AND ROUTE(S) OF ADMINISTRATION

Solvent for Voxzogo
SC use after reconstitution

2. METHOD OF ADMINISTRATION

3. EXPIRY DATE

EXP

4. BATCH NUMBER

Lot

5. CONTENTS BY WEIGHT, BY VOLUME OR BY UNIT

0.5 mL

6. OTHER

For reconstitution of the powder in the vial

MINIMUM PARTICULARS TO APPEAR ON BLISTERS OR STRIPS

0.5 ML PRE-FILLED SYRINGE BLISTER

1. NAME OF THE MEDICINAL PRODUCT

Solvent for Voxzogo
Water for injections
Subcutaneous use after reconstitution
0.5 mL

2. NAME OF THE MARKETING AUTHORISATION HOLDER

BioMarin International Limited

3. EXPIRY DATE

EXP

4. BATCH NUMBER

Lot

5. OTHER



PARTICULARS TO APPEAR ON THE OUTER PACKAGING

0.56 MG CARTON

1. NAME OF THE MEDICINAL PRODUCT

Voxzogo 0.56 mg powder and solvent for solution for injection
vosoritide

2. STATEMENT OF ACTIVE SUBSTANCE(S)

Each vial of powder contains 0.56 mg of vosoritide. After reconstitution, each vial contains 0.56 mg vosoritide in 0.7 mL of solution, corresponding to a concentration of 0.8 mg/mL.

3. LIST OF EXCIPIENTS

Powder: citric acid (E 330), sodium citrate (E 331), trehalose dihydrate, mannitol (E 421), methionine, polysorbate 80 (E 433)
Solvent: water for injections.

4. PHARMACEUTICAL FORM AND CONTENTS

Powder and solvent for solution for injection.

This carton contains:
10 powder vials (0.56 mg)
10 syringes with solvent (0.7 mL)
10 single use needles
10 single use syringes

5. METHOD AND ROUTE(S) OF ADMINISTRATION

For single use only.
Read the package leaflet before use.
Subcutaneous use.

6. SPECIAL WARNING THAT THE MEDICINAL PRODUCT MUST BE STORED OUT OF THE SIGHT AND REACH OF CHILDREN

Keep out of the sight and reach of children.

7. OTHER SPECIAL WARNING(S), IF NECESSARY

8. EXPIRY DATE

EXP

9. SPECIAL STORAGE CONDITIONS

Store in a refrigerator. Do not freeze.

Can be stored at room temperature below 30 °C for a single period up to 90 days.

Store in the original package in order to protect from light.

Date removed from refrigeration: ____/____/____

If not used immediately, vosoritide must be administered within 3 hours of reconstitution.

10. SPECIAL PRECAUTIONS FOR DISPOSAL OF UNUSED MEDICINAL PRODUCTS OR WASTE MATERIALS DERIVED FROM SUCH MEDICINAL PRODUCTS, IF APPROPRIATE**11. NAME AND ADDRESS OF THE MARKETING AUTHORISATION HOLDER**

BioMarin International Limited
Shanbally, Ringaskiddy
County Cork
Ireland
P43 R298

12. MARKETING AUTHORISATION NUMBER(S)

EU/1/21/1577/002

13. BATCH NUMBER

Lot

14. GENERAL CLASSIFICATION FOR SUPPLY**15. INSTRUCTIONS ON USE****16. INFORMATION IN BRAILLE**

Voxzogo 0.56 mg

17. UNIQUE IDENTIFIER – 2D BARCODE

2D barcode carrying the unique identifier included.

18. UNIQUE IDENTIFIER - HUMAN READABLE DATA

PC
SN
NN

MINIMUM PARTICULARS TO APPEAR ON SMALL IMMEDIATE PACKAGING UNITS

0.56 MG VIAL LABEL

1. NAME OF THE MEDICINAL PRODUCT AND ROUTE(S) OF ADMINISTRATION

Voxzogo 0.56 mg powder for injection
vosoritide
SC use

2. METHOD OF ADMINISTRATION

3. EXPIRY DATE

EXP

4. BATCH NUMBER

Lot

5. CONTENTS BY WEIGHT, BY VOLUME OR BY UNIT

0.56 mg

6. OTHER

MINIMUM PARTICULARS TO APPEAR ON SMALL IMMEDIATE PACKAGING UNITS

0.7 ML PRE-FILLED SYRINGE LABEL

1. NAME OF THE MEDICINAL PRODUCT AND ROUTE(S) OF ADMINISTRATION

Solvent for Voxzogo
SC use after reconstitution

2. METHOD OF ADMINISTRATION

3. EXPIRY DATE

EXP

4. BATCH NUMBER

Lot

5. CONTENTS BY WEIGHT, BY VOLUME OR BY UNIT

0.7 mL

6. OTHER

For reconstitution of the powder in the vial

MINIMUM PARTICULARS TO APPEAR ON BLISTERS OR STRIPS

0.7 ML PRE-FILLED SYRINGE BLISTER

1. NAME OF THE MEDICINAL PRODUCT

Solvent for Voxzogo
Water for injections
Subcutaneous use after reconstitution
0.7 mL

2. NAME OF THE MARKETING AUTHORISATION HOLDER

BioMarin International Limited

3. EXPIRY DATE

EXP

4. BATCH NUMBER

Lot

5. OTHER



PARTICULARS TO APPEAR ON THE OUTER PACKAGING

1.2 MG CARTON

1. NAME OF THE MEDICINAL PRODUCT

Voxzogo 1.2 mg powder and solvent for solution for injection
vosoritide

2. STATEMENT OF ACTIVE SUBSTANCE(S)

Each vial of powder contains 1.2 mg of vosoritide. After reconstitution, each vial contains 1.2 mg vosoritide in 0.6 mL of solution, corresponding to a concentration of 2 mg/mL.

3. LIST OF EXCIPIENTS

Powder: citric acid (E330), sodium citrate (E331), trehalose dihydrate, mannitol (E 421), methionine, polysorbate 80 (E 433)
Solvent: water for injections.

4. PHARMACEUTICAL FORM AND CONTENTS

Powder and solvent for solution for injection.

This carton contains:
10 powder vials (1.2 mg)
10 syringes with solvent (0.6 mL)
10 single use needles
10 single use syringes

5. METHOD AND ROUTE(S) OF ADMINISTRATION

For single use only.
Read the package leaflet before use.
Subcutaneous use.

6. SPECIAL WARNING THAT THE MEDICINAL PRODUCT MUST BE STORED OUT OF THE SIGHT AND REACH OF CHILDREN

Keep out of the sight and reach of children.

7. OTHER SPECIAL WARNING(S), IF NECESSARY

8. EXPIRY DATE

EXP

9. SPECIAL STORAGE CONDITIONS

Store in a refrigerator. Do not freeze.

Can be stored at room temperature below 30 °C for a single period up to 90 days.

Store in the original package in order to protect from light.

Date removed from refrigeration: ____/____/____

If not used immediately, vosoritide must be administered within 3 hours of reconstitution.

10. SPECIAL PRECAUTIONS FOR DISPOSAL OF UNUSED MEDICINAL PRODUCTS OR WASTE MATERIALS DERIVED FROM SUCH MEDICINAL PRODUCTS, IF APPROPRIATE**11. NAME AND ADDRESS OF THE MARKETING AUTHORISATION HOLDER**

BioMarin International Limited
Shanbally, Ringaskiddy
County Cork
Ireland
P43 R298

12. MARKETING AUTHORISATION NUMBER(S)

EU/1/21/1577/003

13. BATCH NUMBER

Lot

14. GENERAL CLASSIFICATION FOR SUPPLY**15. INSTRUCTIONS ON USE****16. INFORMATION IN BRAILLE**

Voxzogo 1.2 mg

17. UNIQUE IDENTIFIER – 2D BARCODE

2D barcode carrying the unique identifier included.

18. UNIQUE IDENTIFIER - HUMAN READABLE DATA

PC
SN
NN

MINIMUM PARTICULARS TO APPEAR ON SMALL IMMEDIATE PACKAGING UNITS

1.2 MG VIAL LABEL

1. NAME OF THE MEDICINAL PRODUCT AND ROUTE(S) OF ADMINISTRATION

Voxzogo 1.2 mg powder for injection
vosoritide
SC use

2. METHOD OF ADMINISTRATION

3. EXPIRY DATE

EXP

4. BATCH NUMBER

Lot

5. CONTENTS BY WEIGHT, BY VOLUME OR BY UNIT

1.2 mg

6. OTHER

MINIMUM PARTICULARS TO APPEAR ON SMALL IMMEDIATE PACKAGING UNITS

0.6 ML PRE-FILLED SYRINGE LABEL

1. NAME OF THE MEDICINAL PRODUCT AND ROUTE(S) OF ADMINISTRATION

Solvent for Voxzogo
SC use after reconstitution

2. METHOD OF ADMINISTRATION

3. EXPIRY DATE

EXP

4. BATCH NUMBER

Lot

5. CONTENTS BY WEIGHT, BY VOLUME OR BY UNIT

0.6 mL

6. OTHER

For reconstitution of the powder in the vial

MINIMUM PARTICULARS TO APPEAR ON BLISTERS OR STRIPS

0.6 ML PRE-FILLED SYRINGE BLISTER

1. NAME OF THE MEDICINAL PRODUCT

Solvent for Voxzogo
Water for injections
Subcutaneous use after reconstitution
0.6 mL

2. NAME OF THE MARKETING AUTHORISATION HOLDER

BioMarin International Limited

3. EXPIRY DATE

EXP

4. BATCH NUMBER

Lot

5. OTHER



B. PACKAGE LEAFLET

Package leaflet: Information for the user

Voxzogo 0.4 mg powder and solvent for solution for injection
Voxzogo 0.56 mg powder and solvent for solution for injection
Voxzogo 1.2 mg powder and solvent for solution for injection
vosoritide

▼ This medicine is subject to additional monitoring. This will allow quick identification of new safety information. You can help by reporting any side effects you or your child may get. See the end of section 4 for how to report side effects.

Read all of this leaflet carefully before you start using this medicine because it contains important information for you.

- Keep this leaflet. You may need to read it again.
- If you or your child has any further questions, ask your doctor.
- This medicine has been prescribed for you or your child only. Do not pass it on to others. It may harm them, even if their signs of illness are the same as yours.
- If you or your child gets any side effects, talk to your doctor. This includes any possible side effects not listed in this leaflet. See section 4.

What is in this leaflet

1. What Voxzogo is and what it is used for
2. What you need to know before you use Voxzogo
3. How to use Voxzogo
4. Possible side effects
5. How to store Voxzogo
6. Contents of the pack and other information

1. What Voxzogo is and what it is used for

What Voxzogo is

Voxzogo contains the active substance vosoritide. It is similar to a protein in the body called C type natriuretic peptide (CNP). Vosoritide is made by recombinant technology involving bacteria that have been modified to include the gene for producing the protein.

What Voxzogo is used for

This medicine is used for the treatment of achondroplasia in patients 4 months of age and older whose bones are still growing. Achondroplasia is a genetic condition that affects growth of almost all bones in the body including the skull, spine, arms and legs resulting in very short stature with a characteristic appearance.

The product is indicated only in achondroplasia which is caused by mutations in the FGFR3-gene as confirmed by genetic testing.

How does Voxzogo work

The active substance in Voxzogo works directly on the growth points of your bones to promote new bone growth.

2. What you need to know before you use Voxzogo

Do not use Voxzogo

- if you or your child are allergic to vosoritide or any of the other ingredients of this medicine (listed in section 6).

Warnings and precautions

Talk to your doctor before using Voxzogo:

- If you or your child have significant heart disease or blood pressure problems.
- If you or your child are taking or have recently taken medicines that lower blood pressure.

If any of these applies to you or your child or you are unsure, talk to the doctor before using Voxzogo.

Blood pressure effects

Voxzogo can lower blood pressure. As a result, you may feel dizzy, nauseous, or tired. Blood pressure usually returns to normal within 90 minutes of Voxzogo injection. If these effects occur and are severe, tell your doctor.

Drinking plenty of fluids at the time of injection may reduce the likelihood of these effects. It is recommended patients eat a light snack and drink enough fluid (e.g. water, milk or juice) about 30 minutes before injection.

Children and adolescents

There is not enough information on the use of this medicine in children under 4 months old and therefore it is not recommended.

Other medicines and Voxzogo

Tell your doctor if you or your child are taking, have recently taken or might take any other medicines.

Pregnancy and breast-feeding

If you or your child are being treated with this medicine and are pregnant or breast-feeding, think you may be pregnant or are planning to have a baby, ask your doctor for advice before using this medicine.

The use of this medicine is not recommended during pregnancy and breast-feeding.

Driving, cycling and using machines

This medicine may cause you to feel dizzy, light-headed, tired or you may feel sick shortly after your injection. If this happens, you should not drive, ride a bicycle, do physical activities or use machines for around an hour after injection or until you feel better.

Voxzogo contains sodium

This medicine contains less than 1 mmol sodium (23 mg) per dose, that is to say essentially 'sodium-free'.

3. How to use Voxzogo

A caregiver should give the Voxzogo injection. Do not inject your child with Voxzogo until you have had proper training from a healthcare professional.

Always use this medicine exactly as your doctor has told you. Check with your doctor or pharmacist if you are not sure.

Dose

Your doctor will choose the correct dose depending on your or your child's bodyweight. The doctor will tell you how much of the injection solution to inject. If you are not sure, ask your doctor or pharmacist.

Table 1 shows the dose you or your child will need to inject daily based on bodyweight. The amount to inject may be presented as different volumes based on the type of syringe included in your pack (millilitres (mL) or Units (U)). Please check that you have the correct dose for the syringe you are using.

Table 1: Single dose volumes by body weight in mL and Units (U) volumes

| Body weight (kg) | Dose (mg) | Vosoritide 0.4 mg solvent (water for injections): 0.5 mL concentration: 0.8 mg/mL | | Vosoritide 0.56 mg solvent (water for injections): 0.7 mL concentration: 0.8 mg/mL | | Vosoritide 1.2 mg solvent (water for injections): 0.6 mL concentration: 2 mg/mL | |
|------------------|-----------|--|-------|---|-------|--|-------|
| | | Daily injection volume | | | | | |
| | | mL | Units | mL | Units | mL | Units |
| 4 | 0.12 mg | 0.15 mL | 15 U | | | | |
| 5 | 0.16 mg | 0.20 mL | 20 U | | | | |
| 6-7 | 0.20 mg | 0.25 mL | 25 U | | | | |
| 8-11 | 0.24 mg | 0.30 mL | 30 U | | | | |
| 12-16 | 0.28 mg | | | 0.35 mL | 35 U | | |
| 17-21 | 0.32 mg | | | 0.40 mL | 40 U | | |
| 22-32 | 0.40 mg | | | 0.50 mL | 50 U | | |
| 33-43 | 0.50 mg | | | | | 0.25 mL | 25 U |
| 44-59 | 0.60 mg | | | | | 0.30 mL | 30 U |
| 60-89 | 0.70 mg | | | | | 0.35 mL | 35 U |
| ≥ 90 | 0.80 mg | | | | | 0.40 mL | 40 U |

You or your child should eat a light snack and drink enough water, milk or juice about 30 minutes before the injection. This can reduce side effects such as dizziness, tiredness or nausea (feeling sick).

How to use Voxzogo

Inject Voxzogo slowly under the skin (subcutaneous injection).

The injection should be given at around the same time each day.

It is recommended that you give the injection in a different place each day and do not use the same site 2 days in a row. Do not inject this medicine into moles, scars, birthmarks, or areas where the skin is tender, bruised, red, or hard.

If you use more Voxzogo than you should

If you inject more Voxzogo than you should, contact your doctor straight away.

If you forget to use Voxzogo

If your child misses a dose, the injection should still be given if it is within 12 hours of the scheduled time. If more than 12 hours have passed since the scheduled dose time, do not inject the missed dose. Wait until the next day and continue with the usual dose at the usual time.

If you stop using Voxzogo

Always talk to your child's doctor before deciding to stop your child's treatment. If you or your child have any further questions on the use of this medicine, ask your doctor or pharmacist.

4. Possible side effects

Like all medicines, this medicine can cause side effects, although not everybody gets them.

Very common side effects

These may affect **more than 1 in 10 people**:

- Low blood pressure (temporary effects include dizziness, feeling tired or feeling sick shortly after an injection)
- Vomiting
- Injection site reactions: redness, itching, inflammation, swelling, bruising, rash, hives, pain. Injection site reactions are usually minor and resolve on their own within a few hours
- High levels of blood alkaline phosphatase (shown in blood tests)

Common side effects

These may affect **up to 1 in 10 people**:

- Feeling faint or light-headed and passing out
- Dizziness
- Nausea
- Tiredness

Uncommon side effects

These may affect **up to 1 in 100 people**:

- Abnormal hair growth anywhere on the body in either males or females (hypertrichosis)

Reporting of side effects

If you or your child get any side effects, talk to your doctor or nurse. This includes any possible side effects not listed in this leaflet. You can also report side effects directly via [the national reporting system listed in Appendix V](#). By reporting side effects you can help provide more information on the safety of this medicine.

5. How to store Voxzogo

Keep this medicine **out of the sight and reach of children**.

Do not use this medicine after the expiry date which is stated on the carton after “EXP”. The expiry date refers to the last day of that month.

Store in a refrigerator (2 °C – 8 °C). **Do not freeze**. Store in the original package in order to protect from light.

Voxzogo may be stored at room temperature (below 30 °C) for up to 90 days, but not beyond the expiry date. **Do not** return Voxzogo to refrigerator after storage at room temperature. **Record** on the carton **the date** you remove Voxzogo from the refrigerator to store at room temperature.

Use Voxzogo as soon as it has been made up as a solution. In any case it must be given within 3 hours of making it up. Do not use this medicine if the solution for injection is cloudy or contains any particles.

Do not throw away any medicines via household waste. Ask your pharmacist how to throw away medicines you no longer use. These measures will help protect the environment.

6. Contents of the pack and other information

What Voxzogo contains

- The active substance is vosoritide.
 - Each vial of 0.4 mg powder reconstituted in a solution of 0.5 mL solvent, corresponds to a concentration of 0.8 mg/mL.
 - Each vial 0.56 mg powder reconstituted in a solution of 0.7 mL solvent, corresponds to a concentration of 0.8 mg/mL.
 - Each vial of 1.2 mg powder reconstituted in a solution of 0.6 mL solvent, corresponds to a concentration of 2 mg/mL.
- The other ingredients are citric acid (E 330), sodium citrate (E 331), trehalose dihydrate, mannitol (E 421), methionine, polysorbate 80 (E 433).
- The solvent is water for injections.

What Voxzogo looks like and contents of the pack

Voxzogo powder and solvent for solution for injection is provided as:

- a white to yellow powder for solution for injection in a glass vial, and
- a clear and colourless solvent (water for injections) to dissolve the powder.

After dissolving the powder in the solvent the solution is a clear, colourless to yellow liquid.

Each carton contains:

- 10 vials of Voxzogo
- 10 pre-filled syringes of water for injections
- 10 individual single use needles
- 10 individual single use syringes

Marketing Authorisation Holder and Manufacturer

BioMarin International Limited
Shanbally, Ringaskiddy
County Cork
Ireland
P43 R298

This leaflet was last revised in MM/YYYY.

Detailed information on this medicine is available on the European Medicines Agency web site: <http://www.ema.europa.eu>. There are also links to other websites about rare diseases and treatments.

Instructions for use of the syringe graduated in millilitres (mL)

Please read these Instructions for use before using Voxzogo and each time you get a refill. There may be new information.

Items provided to inject Voxzogo (see Figure A)

Figure A

Voxzogo vial

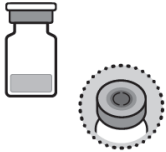

Solvent needle
(blue tab retracts needle)

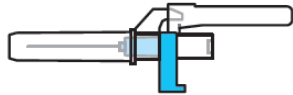

Solvent syringe
(Contains water for injections for reconstitution of Voxzogo)

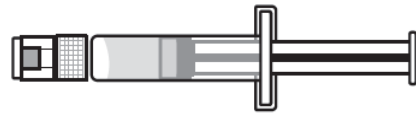

Injections syringe



Please speak to your doctor or healthcare professional if you are unsure of your recommended dose or how to use the solvent needle and injection syringe.

Items needed but *not* provided in the pack (see figure B)

If you don't have these items, ask your pharmacist.

Figure B

Alcohol pads



Sharps container



Gauze or bandage

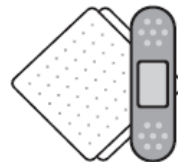

PREPARING FOR INJECTION

Before you start, make sure you have a clean work surface and that you have washed your hands.

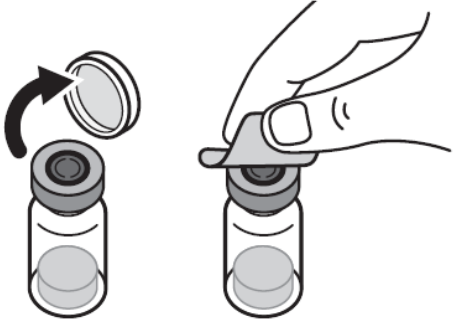
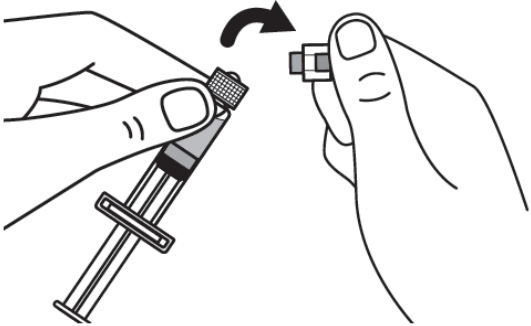
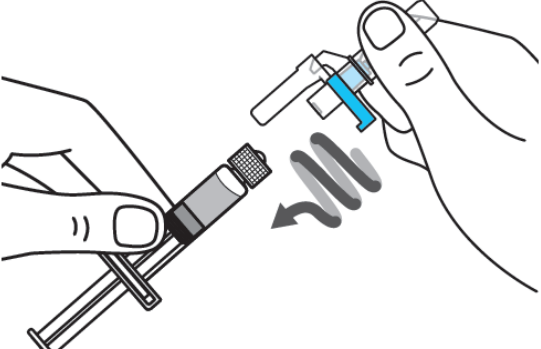
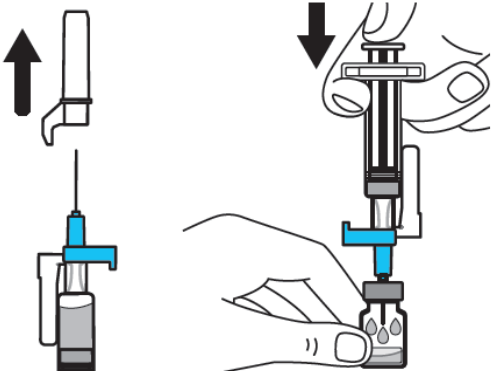
| | |
|---|--|
| <p>Step 1: On a clean flat surface, flip off the vial cap and wipe the top with an alcohol pad.</p> <p>Do not touch the vial stopper with your fingers after wiping it with an alcohol pad.</p> |  |
| <p>Step 2: Gently bend to snap off the cap from the solvent syringe.</p> |  |
| <p>Step 3: Twist the solvent needle onto the solvent syringe until you can no longer twist it.</p> |  |
| <p>Step 4: Pull off the needle cap and insert the needle into the vial through the middle of the vial stopper. Slowly push the plunger rod down to inject all of the liquid.</p> <p>Be careful not to push the blue tab until Step 5.</p> |  |

Step 5: Remove the needle from the vial, then press the blue tab for the needle to pull back (retract). Throw away the needle and syringe into a sharps container.

See step 19 and “How to throw away (dispose of) Voxzogo.”

Do not use the solvent syringe to give the injection.

⚠ ATTENTION: Be careful not to touch the needle tip.

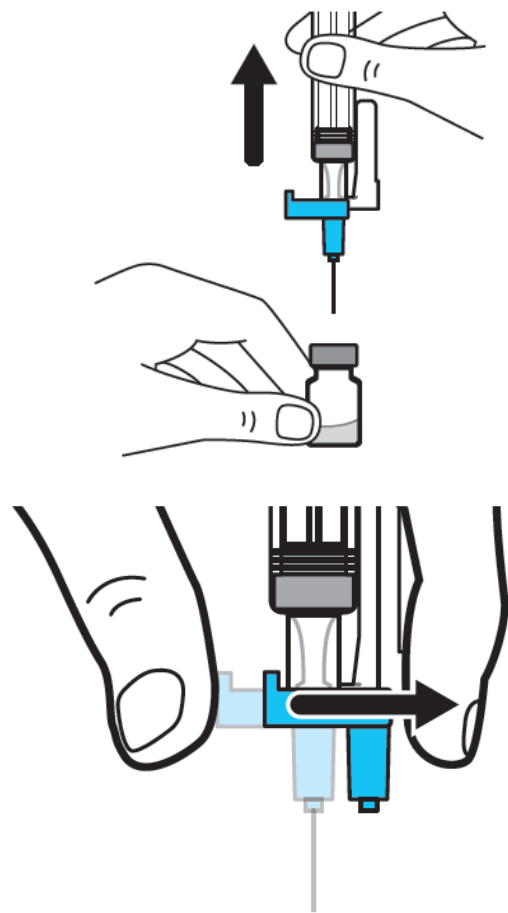

Step 6: Gently swirl the vial until the powder has completely dissolved and the solution is clear.

Do not shake.

Make sure medicine is clear to yellow, not cloudy and is particle-free.

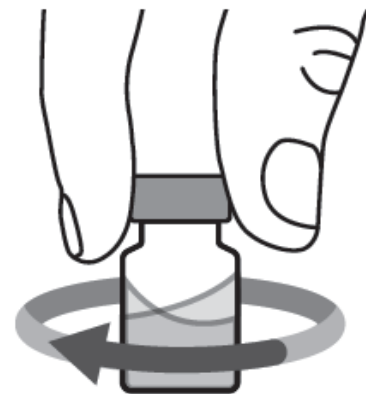

Step 7: Pull off the needle cap from the injection syringe and insert the needle into the vial straight through the middle of the vial stopper.

Be careful not to bend the needle.

⚠ ATTENTION: Do not place the cap back on the needle.

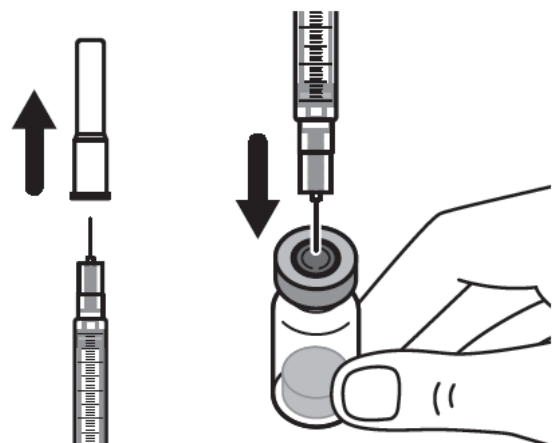

Step 8: Carefully hold the vial and syringe and turn the vial upside down with the needle still inserted. The vial should be on top.

Be careful not to bend the needle.

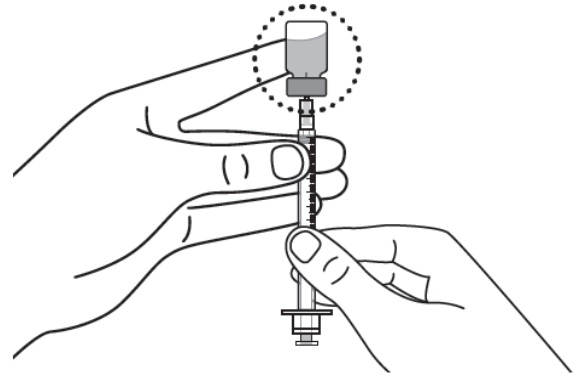

Step 9: Keep the needle tip in the medicine and slowly pull the plunger rod back to draw up the prescribed dose in the syringe.

Check the prescription label for how much to draw up.

⚠ ATTENTION: Draw up the prescribed dose.

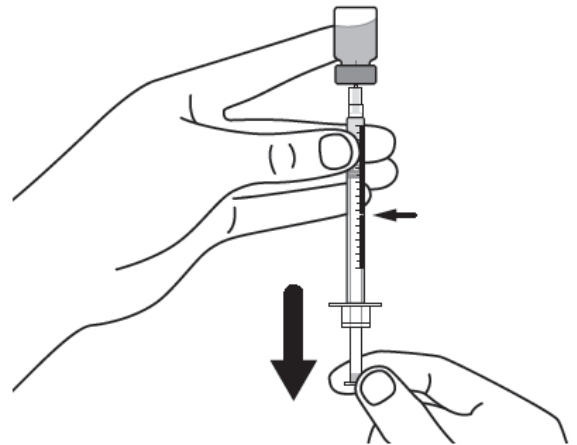

Step 10: Remove large air bubbles in the syringe by gently tapping the syringe. Then **slowly** push the bubbles back into the vial.

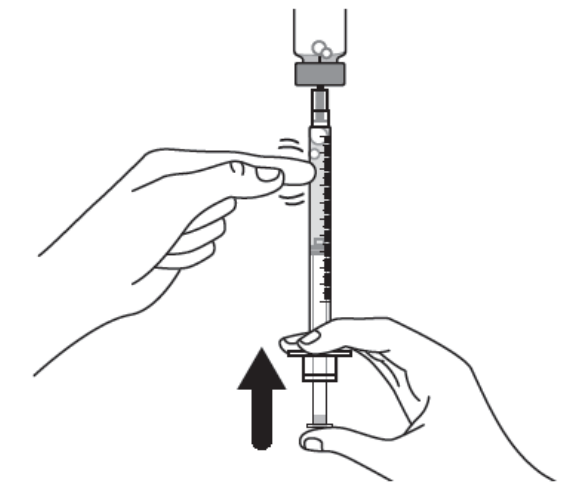

Step 11: Repeat steps 9 and 10 until you have the correct prescribed dose in the syringe and no large bubbles.

Make sure the dose in the syringe matches the prescribed dose. Measure from the base of the plunger as shown.

⚠ ATTENTION: Remove any large bubbles. 1 or 2 small bubbles are acceptable.

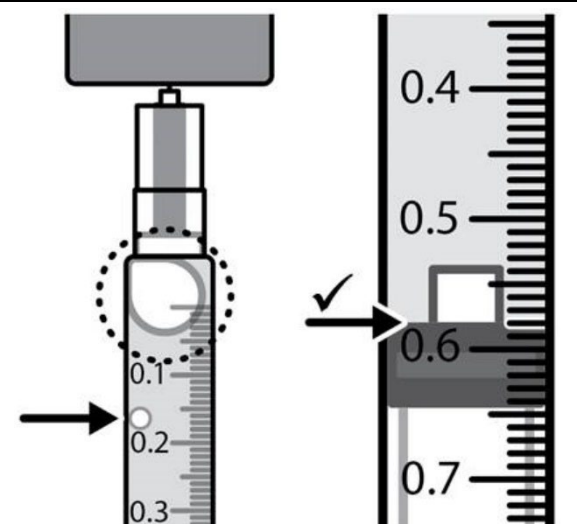

Step 12: Make sure you have the prescribed dose in the syringe, then remove the vial and prepare to give the dose.

⚠ ATTENTION: Confirm amount matches the prescribed dose before removing vial.

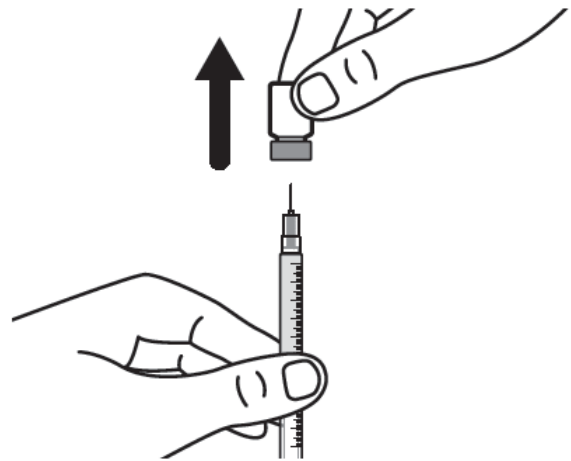

SELECTING AND PREPARING INJECTION SITE

Step 13: Voxzogo should be injected into the fatty layer under the skin (subcutaneous) only.

- Do not inject through clothes.
- Do not inject in the same site two times in a row.
- Do not inject into skin that is sore, bruised, red, hard, or scarred.

The following sites are recommended for injection:

- **Back of upper arms** or
- **Thighs** or
- **Abdomen** (5 centimetres from belly button)
- **Buttocks**

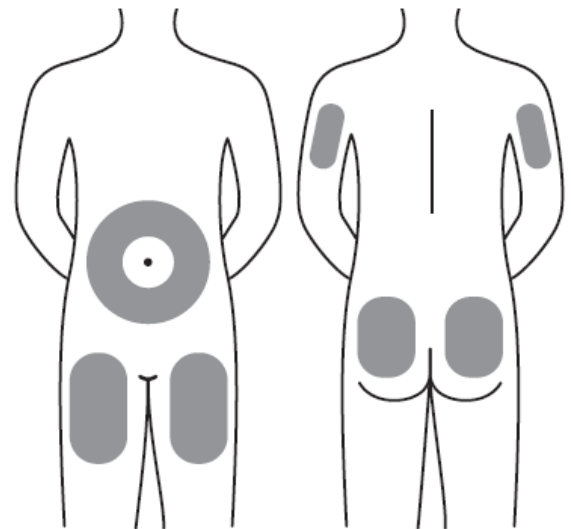

Step 14: Wipe the injection site with an alcohol pad and let the skin air dry.

Do not touch the area again before injecting.

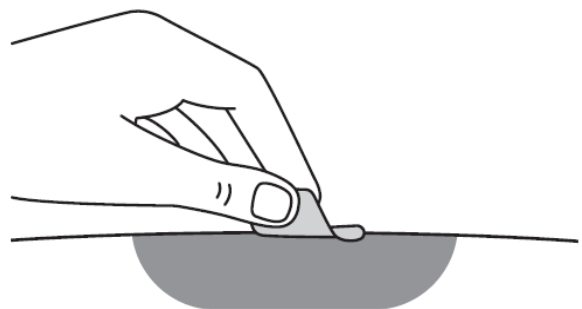

GIVING VOXZOGO INJECTION

Step 15: After wiping the site with an alcohol pad, pinch the skin up around the selected injection site.

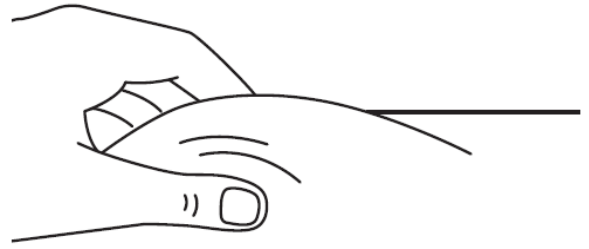

Step 16: Quickly insert the needle all the way into the skin at a 45-degree angle.

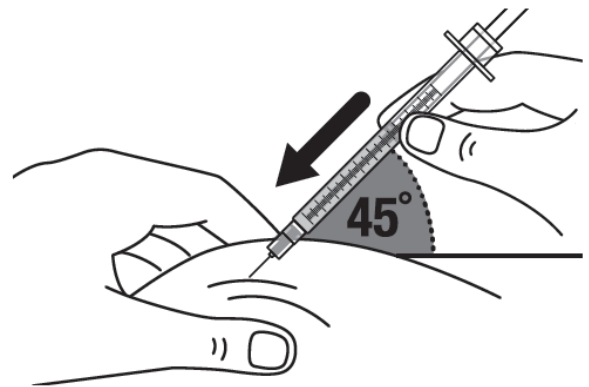

Step 17: Release the pinch and slowly push the plunger rod all the way. Inject full dose.

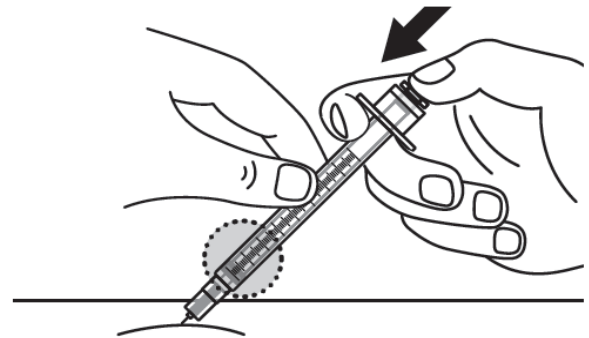

Step 18: Continue pressing the plunger rod until the needle retracts into the syringe.

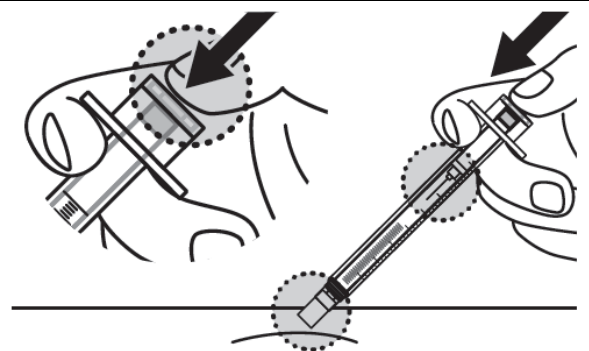

Step 19: Throw away the used vial, syringes and needles in a sharps container. See “How to Throw Away (Dispose of) Voxzogo” for more information.

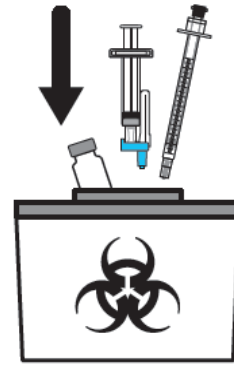

After injecting Voxzogo

- Check the injection site. If there is a small amount of blood at the injection site, gently press a gauze pad on it for a few seconds or apply a bandage.
- **Do not** rub the injection site.
- Look out for signs of low blood pressure, such as dizziness, tiredness, or feeling sick. If you have these symptoms call your doctor or healthcare provider, then lie down on your back and place cushions under your legs to raise them.

How to throw away (dispose of) Voxzogo

Put your used or expired vials, needles and syringes in a sharps disposal container right away after use.

If you do not have a sharps disposal container, you may use a household container that:

- is made of a heavy-duty plastic
- can be closed with a tight fitting, puncture-resistant lid without sharps being able to come out
- is upright and stable during use
- is leak-resistant, and
- is properly labelled to warn of hazardous waste inside the container

When your sharps disposal container is almost full, you will need to follow your local guidelines for the right way to dispose of your sharps disposal container.

Do not throw away any medicines, vials, loose needles and syringes via household waste. Ask your pharmacist how to throw away medicines you no longer use. These measures will help protect the environment.

Instructions for use of the syringe graduated in units (U)

Please read these Instructions for use before using Voxzogo and each time you get a refill. There may be new information.

The solvent needles and administration syringes provided in this pack are new components and marked with “Units” (U) for measuring your recommended dose. Your doctor will tell you the recommended dose to administer based on your weight range.

Items provided to inject Voxzogo (see Figure A)

Figure A

Voxzogo vial

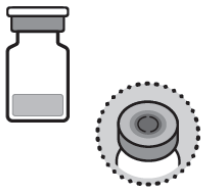

Solvent needle

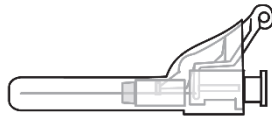

Solvent syringe

(Contains water for injections for reconstitution of Voxzogo)

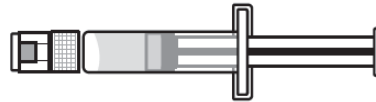

Injection syringe



Your dose can be delivered using the injection syringe in Figure A. The measurements for this syringe are equivalent to mL as follows: 0.1 mL = 10 Units.

Please speak to your doctor or healthcare professional if you are unsure of your recommended dose or how to use the solvent needle and injection syringe.

Items needed but *not* provided in the pack (see figure B)

If you don't have these items, ask your pharmacist.

Figure B

Alcohol pads



Sharps container

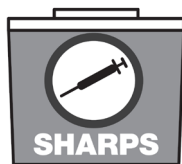

Gauze or bandage

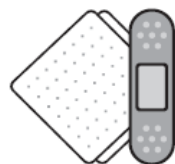

PREPARING FOR INJECTION

Before you start, make sure you have a clean work surface and that you have washed your hands.

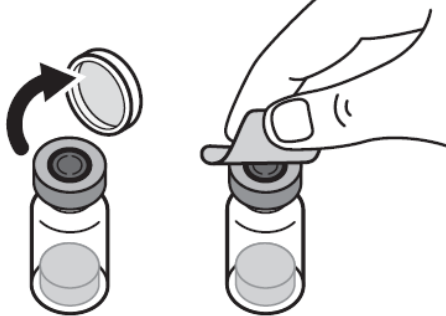
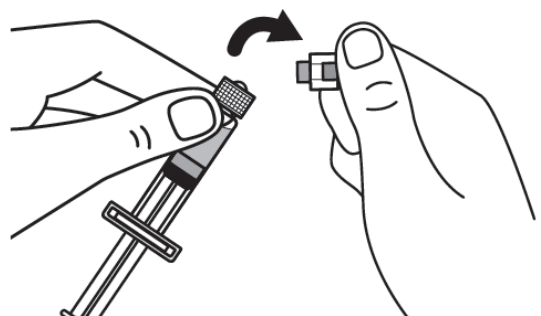
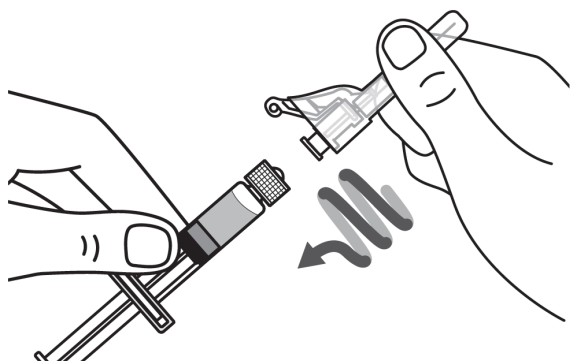
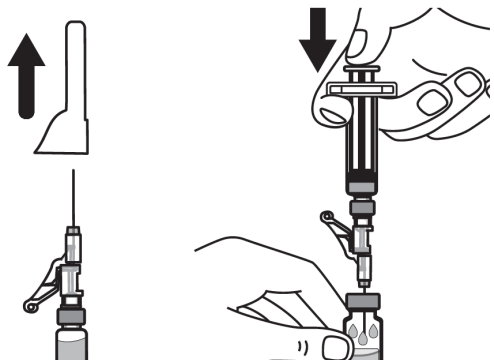
| | |
|---|--|
| <p>Step 1: On a clean flat surface, flip off the vial cap and wipe the top with an alcohol pad.</p> <p>Do not touch the vial stopper with your fingers after wiping it with an alcohol pad.</p> |  |
| <p>Step 2: Gently bend to snap off the cap from the solvent syringe.</p> |  |
| <p>Step 3: Twist the solvent needle onto the solvent syringe until you can no longer twist it.</p> |  |
| <p>Step 4: Pull off the needle cap and insert the needle into the vial through the middle of the vial stopper. Slowly push the plunger rod down to inject all of the liquid.</p> |  |

Step 5: Remove the needle from the vial. Throw away the needle and syringe into a sharps container.

See step 18 and “How to throw away (dispose of) Voxzogo.”

Do not use the solvent syringe to give the injection.

⚠ ATTENTION: Be careful not to touch the needle tip.

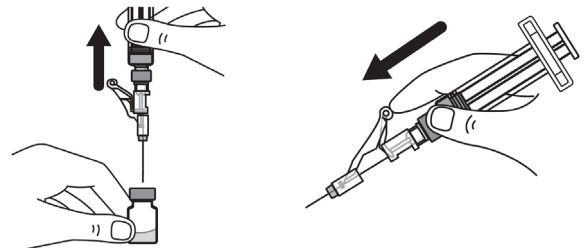

Step 6: Gently swirl the vial until the powder has completely dissolved and the solution is clear.

Do not shake.

Make sure medicine is clear to yellow, not cloudy and is particle-free.

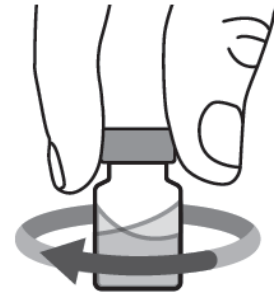

Step 7: Pull off the needle cap from the injection syringe and insert the needle into the vial straight through the middle of the vial stopper.

Be careful not to bend the needle.

⚠ ATTENTION: Do not place the cap back on the needle.

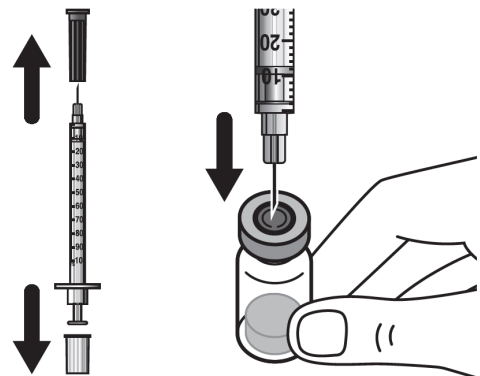

Step 8: Carefully hold the vial and syringe and turn the vial upside down with the needle still inserted. The vial should be on top.

Be careful not to bend the needle.

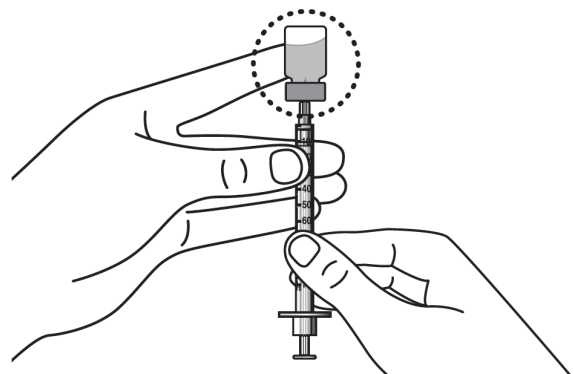

Step 9: Keep the needle tip in the medicine and slowly pull the plunger rod back to draw up the prescribed dose in the syringe.

Check the prescription label for how much to draw up.

⚠ ATTENTION: check the syringe provided in the pack and draw up the prescribed dose.

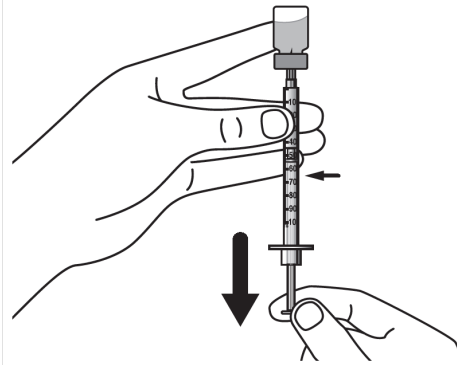

Step 10: Remove large air bubbles in the syringe by gently tapping the syringe. Then **slowly** push the bubbles back into the vial.

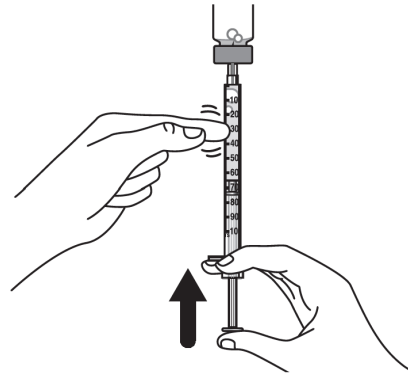

Step 11: Repeat steps 9 and 10 until you have the correct prescribed dose in the syringe and no large bubbles.

Make sure the dose in the syringe matches the prescribed dose. Measure from the base of the plunger as shown.

⚠ ATTENTION: Remove any large bubbles. 1 or 2 small bubbles are acceptable.

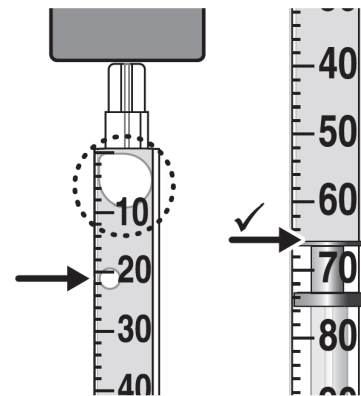

Step 12: Make sure you have the prescribed dose in the syringe, then remove the vial and prepare to give the dose.

⚠ ATTENTION: Confirm amount matches the prescribed dose before removing vial.

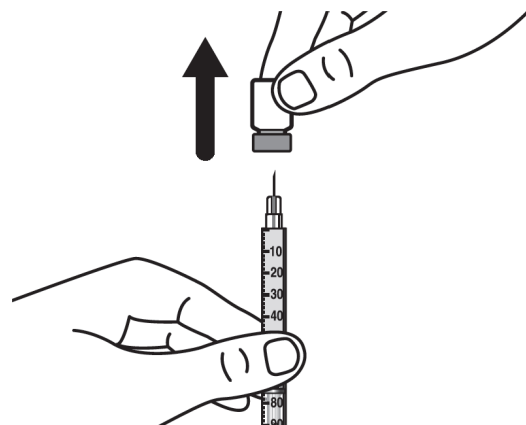

SELECTING AND PREPARING INJECTION SITE

Step 13: Voxzogo should be injected into the fatty layer under the skin (subcutaneous) only.

- Do not inject through clothes.
- Do not inject in the same site two times in a row.
- Do not inject into skin that is sore, bruised, red, hard, or scarred.

The following sites are recommended for injection:

- **Back of upper arms** or
- **Thighs** or
- **Abdomen** (5 centimetres from belly button)
- **Buttocks**

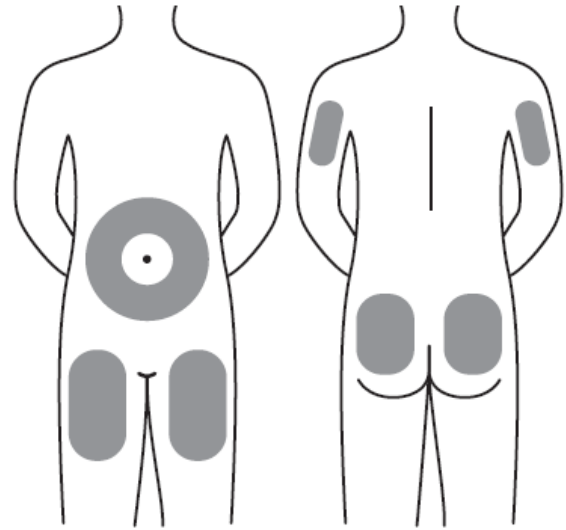

Step 14: Wipe the injection site with an alcohol pad and let the skin air dry.

Do not touch the area again before injecting.

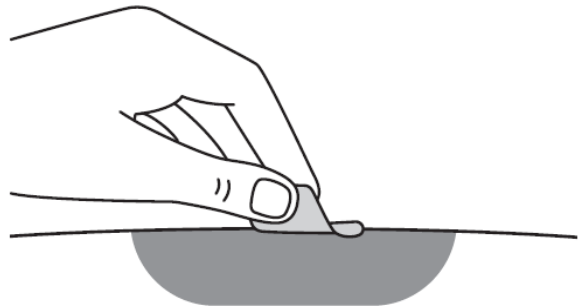

GIVING VOXZOGO INJECTION

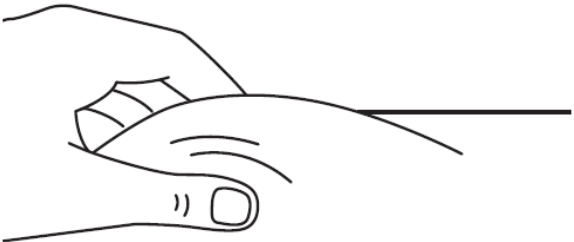
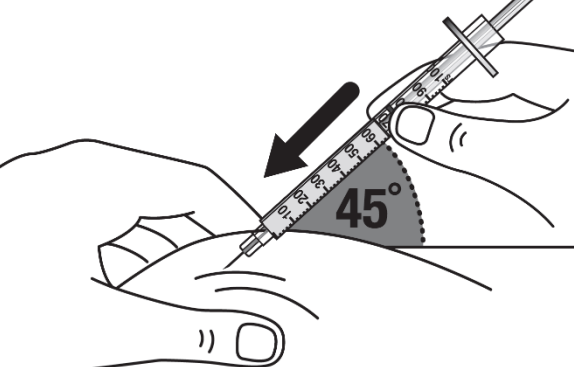
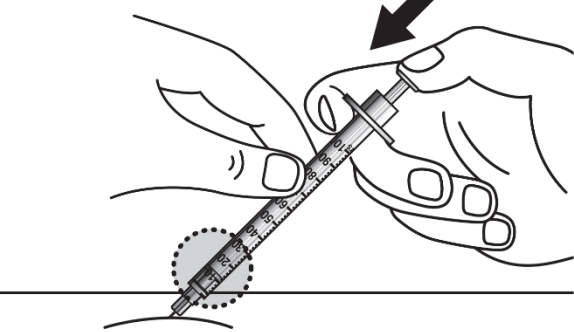
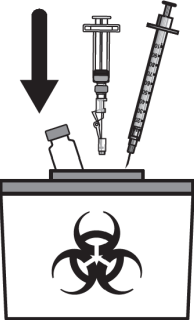
| | |
|---|---|
| <p>Step 15: After wiping the site with an alcohol pad, pinch the skin up around the selected injection site.</p> |  |
| <p>Step 16: Quickly insert the needle all the way into the skin at a 45-degree angle.</p> |  |
| <p>Step 17: Release the pinch and slowly push the plunger rod all the way. Inject full dose.</p> |  |
| <p>Step 18: Throw away the used vial, syringes and needles in a sharps container. See “How to Throw Away (Dispose of) Voxzogo” for more information.</p> |  |

After injecting Voxzogo

- Check the injection site. If there is a small amount of blood at the injection site, gently press a gauze pad on it for a few seconds or apply a bandage.
- **Do not** rub the injection site.
- Look out for signs of low blood pressure, such as dizziness, tiredness, or feeling sick. If you have these symptoms call your doctor or healthcare provider, then lie down on your back and place cushions under your legs to raise them.

How to throw away (dispose of) Voxzogo

Put your used or expired vials, needles and syringes in a sharps disposal container right away after use.

If you do not have a sharps disposal container, you may use a household container that:

- is made of a heavy-duty plastic
- can be closed with a tight fitting, puncture-resistant lid without sharps being able to come out
- is upright and stable during use
- is leak-resistant, and
- is properly labelled to warn of hazardous waste inside the container

When your sharps disposal container is almost full, you will need to follow your local guidelines for the right way to dispose of your sharps disposal container.

Do not throw away any medicines, vials, loose needles and syringes via household waste. Ask your pharmacist how to throw away medicines you no longer use. These measures will help protect the environment.

ANNEX IV

**SCIENTIFIC CONCLUSIONS AND GROUNDS FOR THE VARIATION TO THE TERMS
OF THE MARKETING AUTHORISATION(S)**

Scientific conclusions

Taking into account the PRAC Assessment Report on the PSUR(s) for vosoritide, the scientific conclusions of PRAC are as follows:

In view of available data on the risk of hypertrichosis from clinical trials and spontaneous reports including cases with a close temporal relationship and with no alternative explanation, although, there is no data on a biological mechanism, the PRAC considers a causal relationship between vosoritide and hypertrichosis at least reasonable. The PRAC concluded that the product information of products containing vosoritide should be amended accordingly.

Having reviewed the PRAC recommendation, the CHMP agrees with the PRAC overall conclusions and grounds for recommendation.

Grounds for the variation to the terms of the marketing authorisation(s)

On the basis of the scientific conclusions for vosoritide the CHMP is of the opinion that the benefit-risk balance of the medicinal product(s) containing vosoritide is unchanged subject to the proposed changes to the product information

The CHMP recommends that the terms of the marketing authorisation(s) should be varied.